

# EC Fan QBW6/3

## Double Inlet Centrifugal Fan

### General Characteristics:



[Please note - image above may not be representative of the unit supplied]

<b>Motor type:</b>	EC (Electronically Commutated) motors IP54 Integrated speed control via PWM or 0-10V signal
<b>Nominal supply:</b>	230V 1Ph 50/60Hz
<b>Options:</b>	Potentiometer 0-10V speed controller; inlet & discharge guards, spigots, inlet filters
<b>Materials:</b>	Fancase - cast aluminium LM6 Impeller - galvanised sheet steel
<b>Finishes:</b>	Unpainted or stove enamel as std (black)
<b>Mounting options:</b>	Inlet & discharge drillings
<b>Noise levels:</b>	85.2dB(A) Free Air; 1 metre
<b>Weight:</b>	5.0Kg/11.0Lbs

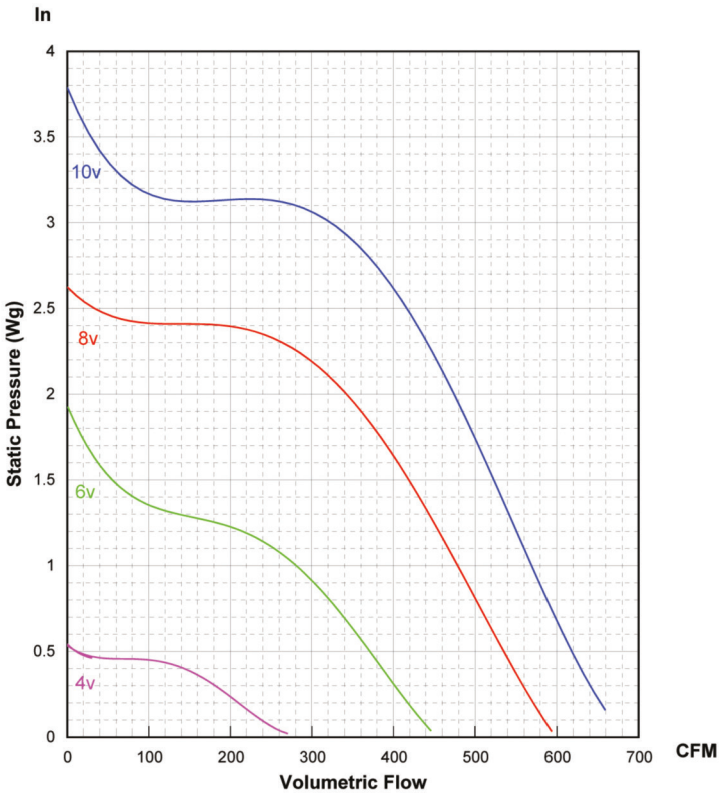

### Outline dimensions:

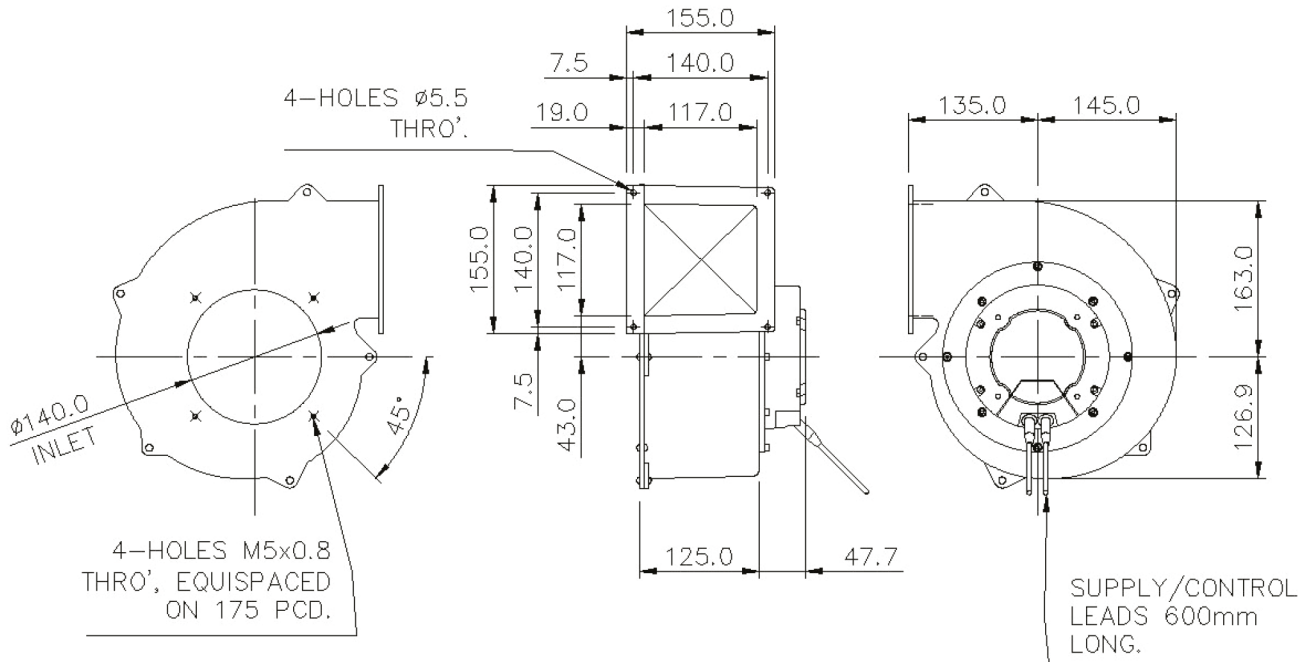

Please note (1) - all drawings measurements are in millimeters (mm)  
Please note (2) - above technical specifications are subject to change