

Double stage Lateral Channel Blowers Compressor - 50Hz X2.14 SM



Main Features

- Compliance with the ATEX Directive 94/9/EC
- Compliance with the Machinery Directive 2006/42/CE
- Maximum flow: 135 m³/h
- Maximum Pressure: 425 mbar
- Aluminium alloy parts non sparking
- Motors ATEX Ex nA IIB T4 Gc with PTC sensor
- Suitable for horizontal and vertical installation (for Biogas application, only vertical)
- Inlet / Outlet ports: G 1 1/2"

For Biogas application (to be listed at order)

- Anodizing
- Impregnation
- Provision for pressure and temperature control sensors
- Drain holes
- Only vertical installation with No. 3 vibration dampers included (Refer to the doc: "Overall dimensions for Biogas application")

MARKING

- Zone 2, Cat 3G (GAS)
 - II 3G c IIB T4
- Zone 22, Cat 3D (DUST)
 - II 3D c T135°C
- For Biogas application
 - Zone 2, Cat 3G (GAS)
 - II 3G cb IIB T3



Technical Data for 50Hz - 2 poles - Three-Phase Motors ⁽⁵⁾

Order Code	Maximum flow [m ³ /h]	Maximum Differential Pressure Δp [hPa]	Electric Motor data			Noise level Lp ⁽³⁾ [dB (A)]	Weight [kg]
			Installed Power [kW]	Voltage ⁽²⁾ Δ/Y [V]	Rated Amps Δ/Y [A]		
X2.14-2.2	135	400	2,2	230/400	9,4 / 5,4	66,5	30
X2.14-3.0	135	425	3,0	230/400	11,8 / 6,8	67,0	33

Performance Diagrams [50Hz] ⁽¹⁾

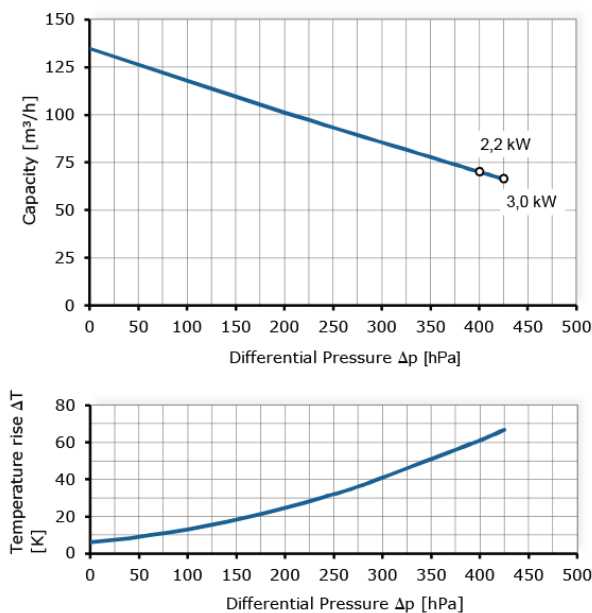

Notes:

- (1) Performance curves refer to operative conditions to air at 15°C temperature and 1013 hPa (abs) pressure measured at inlet port. Tolerance on capacity and temperature values: +/-10%. 1 hPa = 1 mbar
- (2) Allowed tolerance for supplied voltage: +/-10%.
- (3) Noise measured at 1 meter distance in accordance to EN ISO 3744, tolerance: +/-3 dB (A).
- (4) Tolerance about dimensions according to: ISO 2768-c.
- (5) For use with frequencies different from 50Hz, refer to variable frequency table.

Overall Dimensions [mm] ⁽⁴⁾

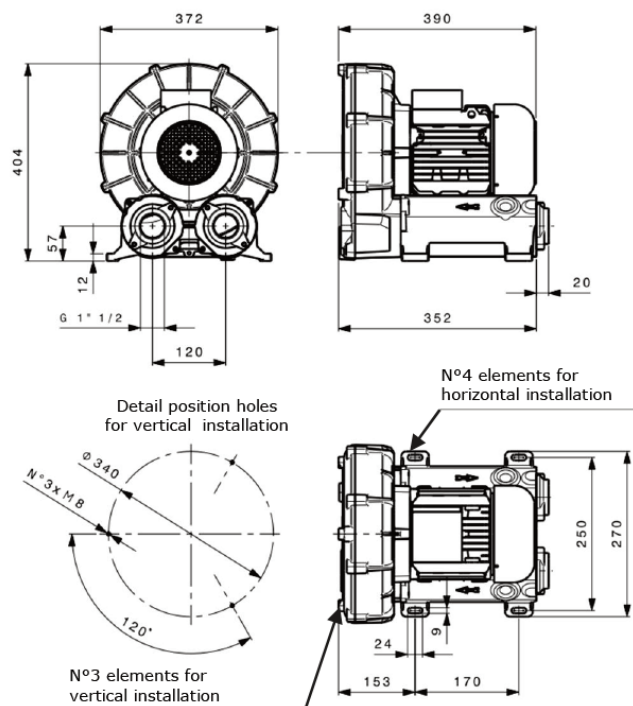

For proper installation and safe use of the blower it must be equipped with relief valve and air filter in accordance with 94/9/EC Atex Directive.
For further details ask for the Compressor connection diagram.